



EQUIPOS DE ALUMINIO BRAZADO



Contamos con intercambiadores de calor de aluminio brazado con versas conformaciones para distintos requerimientos y sectores de la industria.

Equipos para compresores, secadores de aire, maquinaria pesada de transporte minería y construcción.

Estructura básica del tubo

Basic structure of the pipe

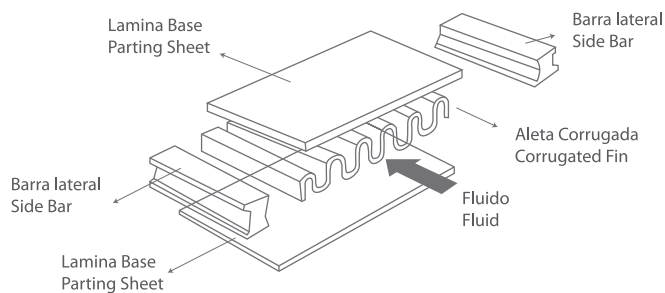

Aleta de rizo

Panel fin

Paso: 2.5 a 5 mm
G: 0.1 a 0.17 mm
H: 6.5 a 18 mm

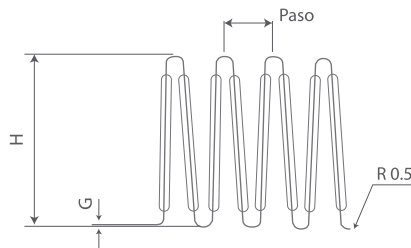

Aleta ondulada

Waved fin

Paso: 2.1 a 10 mm
G: 0.1 a 0.35 mm
H: 2.5 a 12 mm

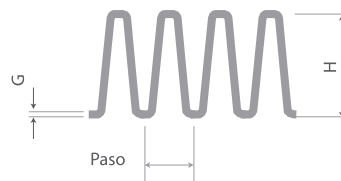

Aleta plana

Flat fin

Paso: 2.1 a 10 mm
G: 0.1 a 0.2 mm
H: 2.5 a 12 mm

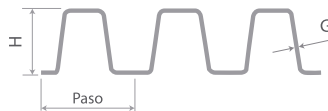

Aleta desplazada

Offset fin

Paso: 4.5 a 8 mm
G: 0.15 a 0.5 mm
H: 1 a 5 mm

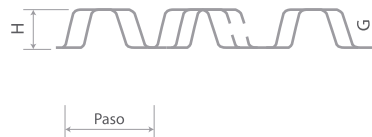

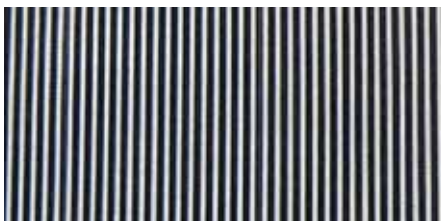
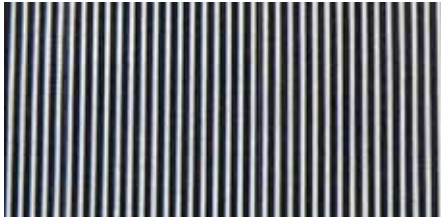

Panal RV007

MARCA MODELO	ALTO	ANCHO	ESPESOR
Volvo B-7 C	880	675	58

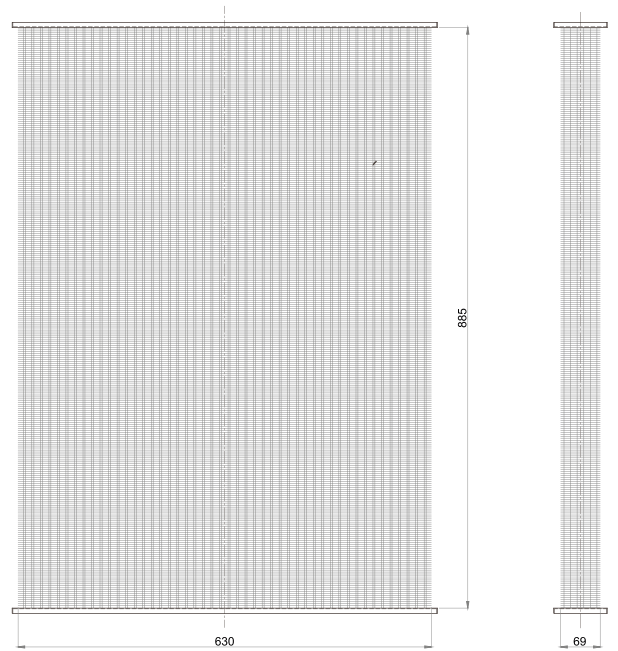

Panal RV009

MARCA MODELO	ALTO	ANCHO	ESPESOR
Volvo B7E - B7R - B12R	900	730	52

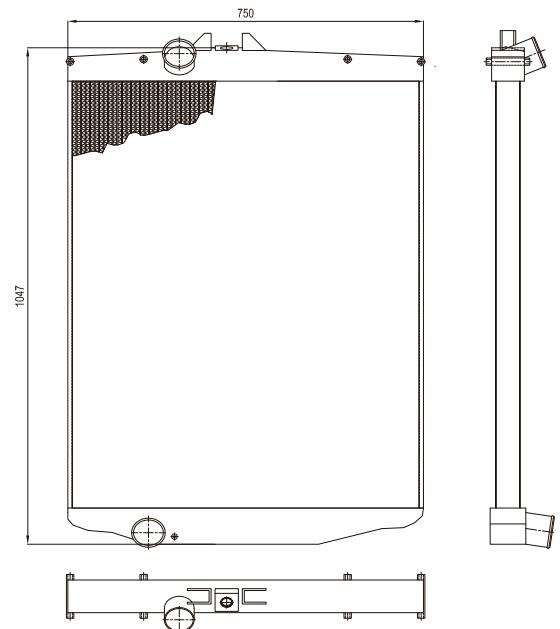

Panel / Radiador RM015

MARCA MODELO	ALTO	ANCHO	ESPEJOR
M/benz O500	925	645	66

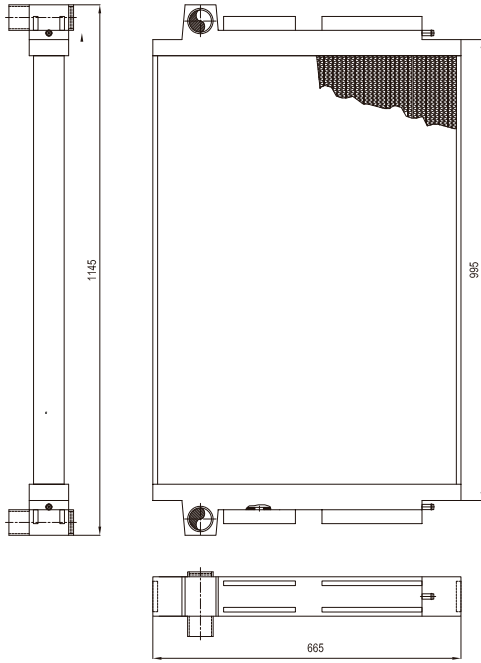
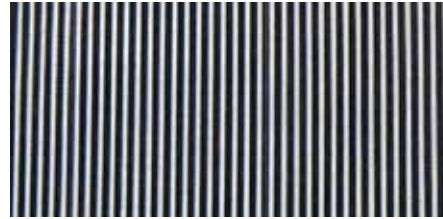

Panel Intercooler IV008

MARCA MODELO	ALTO	ANCHO	ESPEJOR
Volvo B7E - B7R - B12R	885	630	69

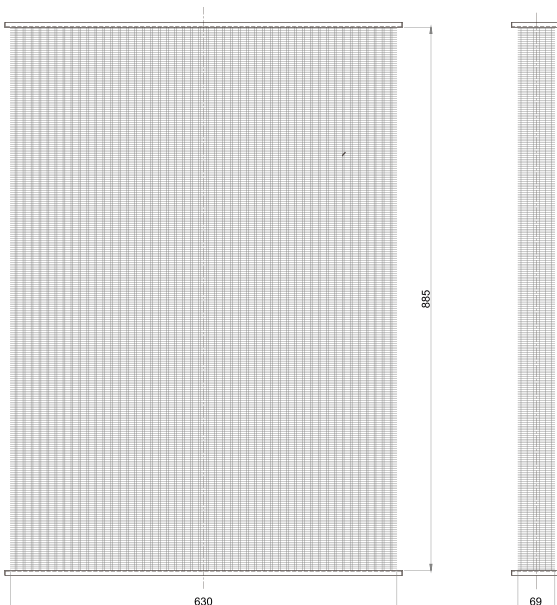



Panel / Radiador RS011

MARCA	MODELO	ALTO	ANCHO	ESPESOR
Scania	Serie 4 Bus	880	693	65

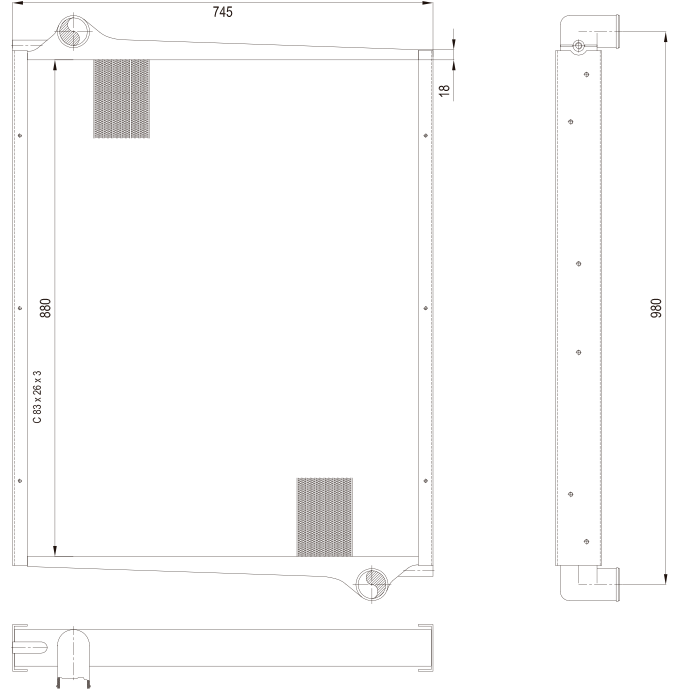

Panel Intercooler IS034

MARCA	MODELO	ALTO	ANCHO	ESPESOR
Scania	Serie 4 Bus	830	570	60

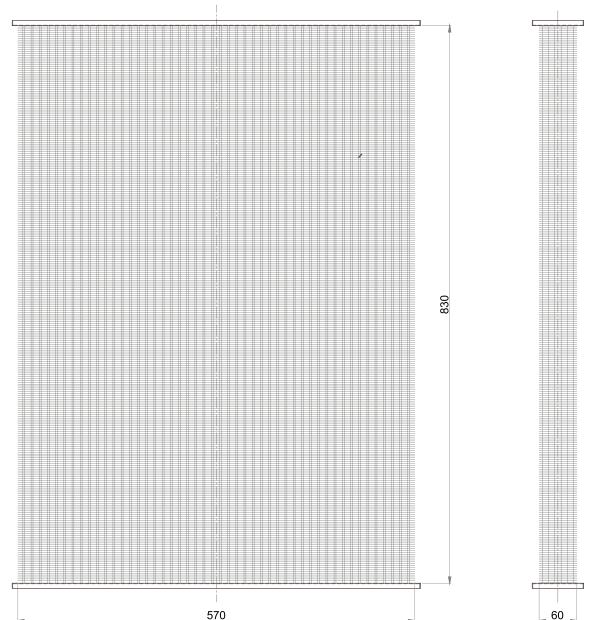
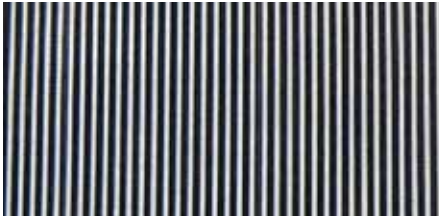

Panal Intercooler IM037

MARCA MODELO	ALTO	ANCHO	ESPESOR
M/ Benz O500RS	920	640	60

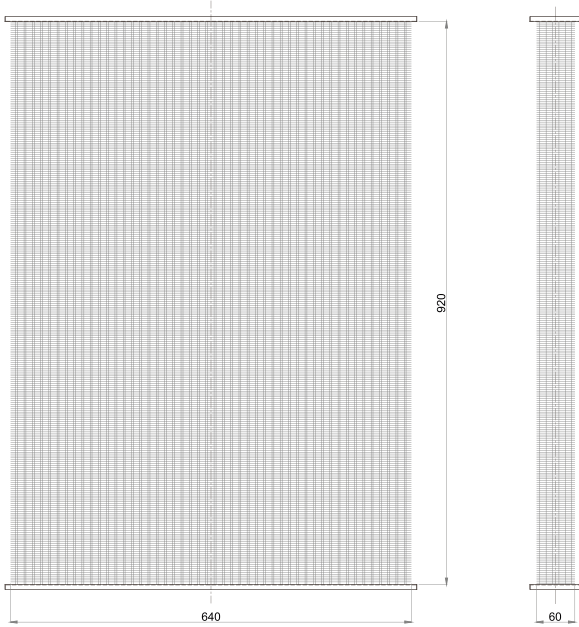
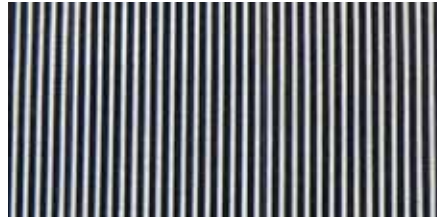

Panal Intercooler IM016

MARCA MODELO	ALTO	ANCHO	ESPESOR
M/benz 0500RSD	865	790	60

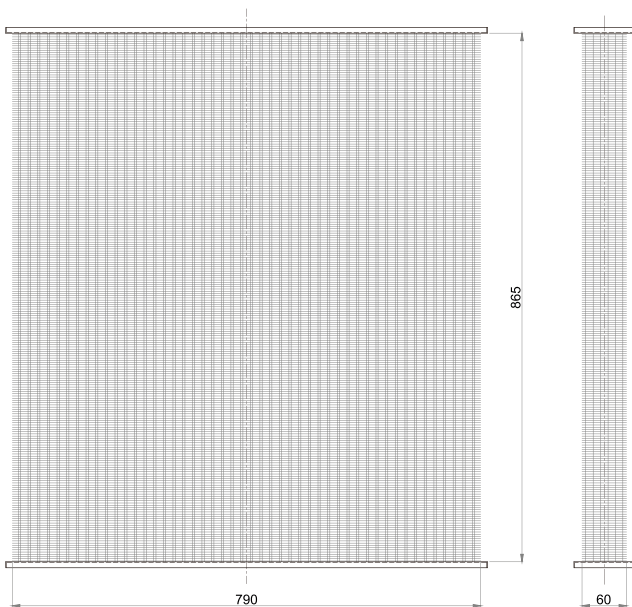
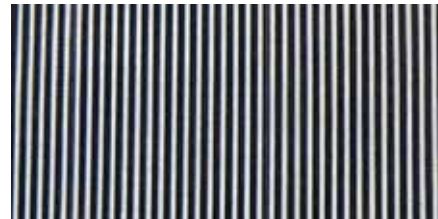

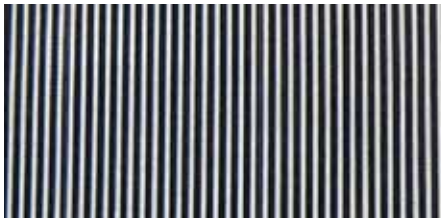

Panal Enf. de Aceite EM035

MARCA MODELO	ALTO	ANCHO	ESPESOR
Mixer camión tolva	300	300	65

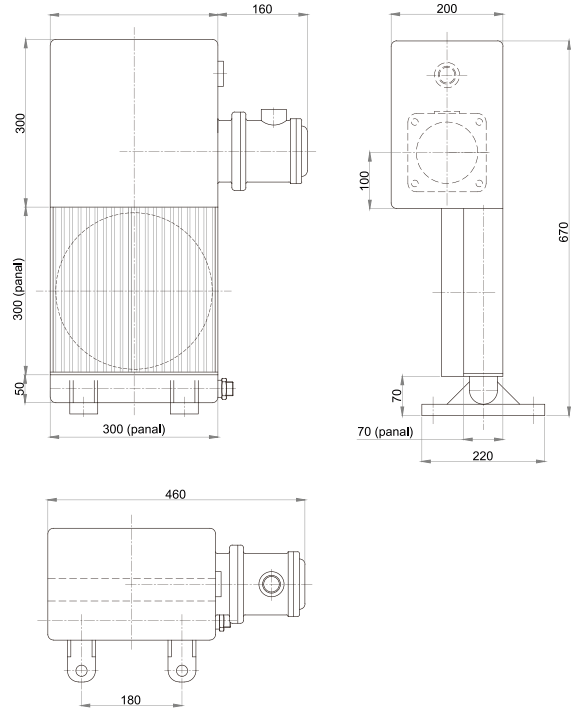

Panal Intercooler IM036

MARCA MODELO	ALTO	ANCHO	ESPESOR
M/Benz 400/447	780	540	60

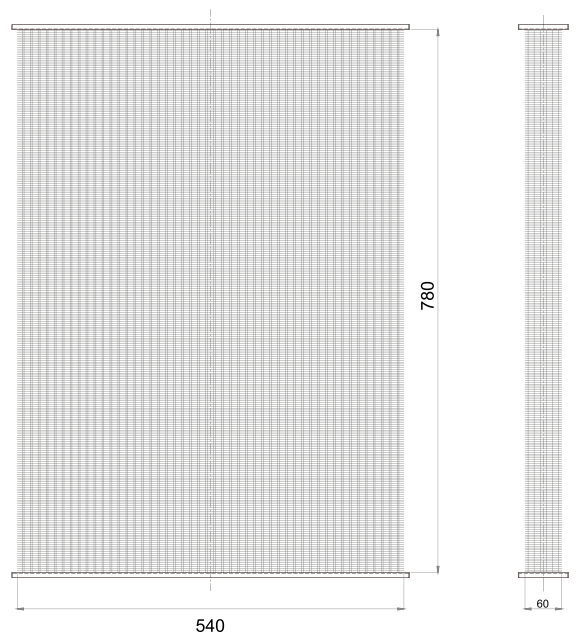

Radiador RV003

MARCA MODELO	ALTO	ANCHO	ESPESOR
Volvo B-9	973	560	52

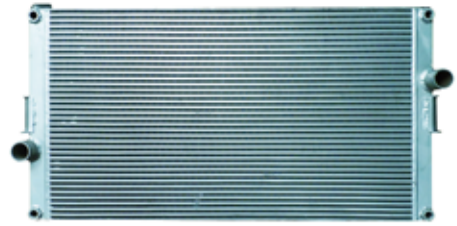
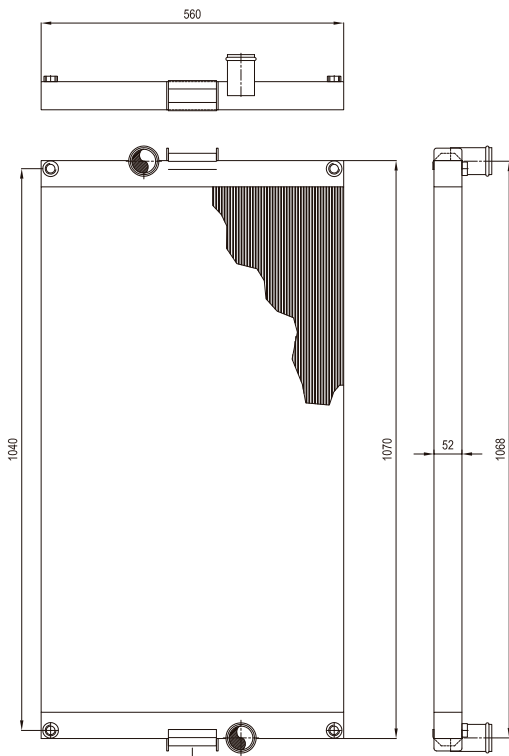

Radiador RI005

MARCA MODELO	ALTO	ANCHO	ESPESOR
Inter 7600	1043	718	55

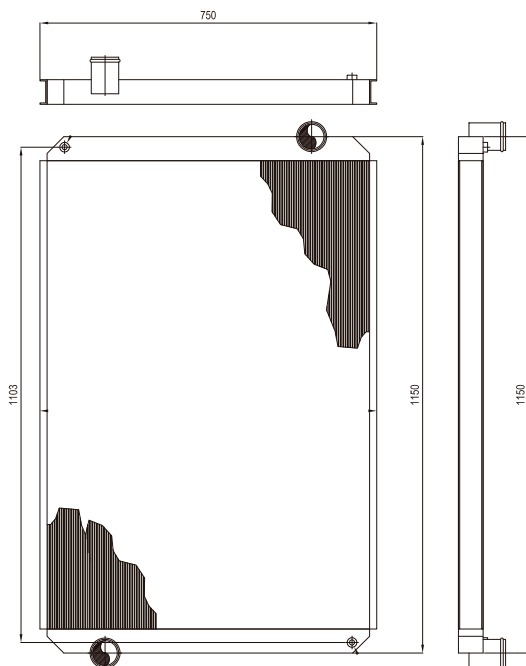



Radiador RY029

MARCA MODELO	ALTO	ANCHO	ESPESOR
Youngman	900	935	80

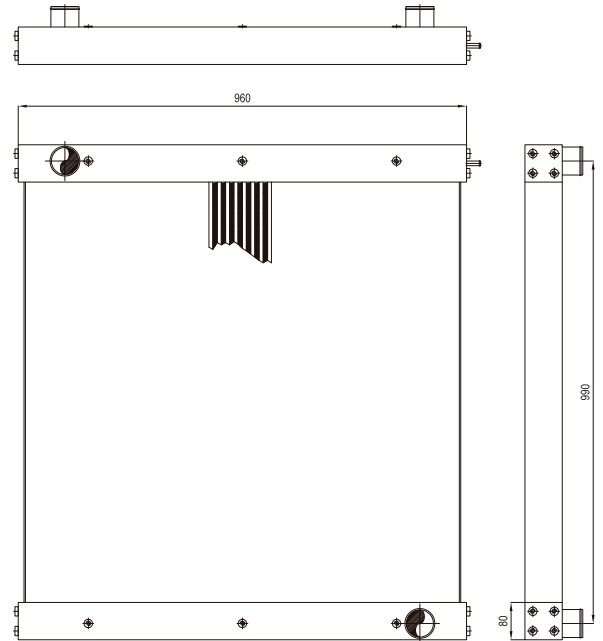

Radiador RS001

MARCA MODELO	ALTO	ANCHO	ESPESOR
Scania 380	860	717	55

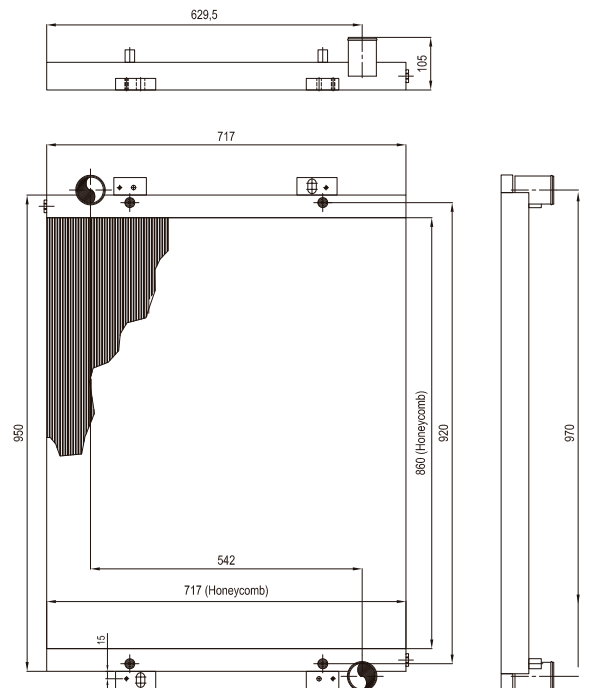

Intercooler IV004

MARCA MODELO	ALTO	ANCHO	ESPESOR
Volvo B-9	1000	490	70

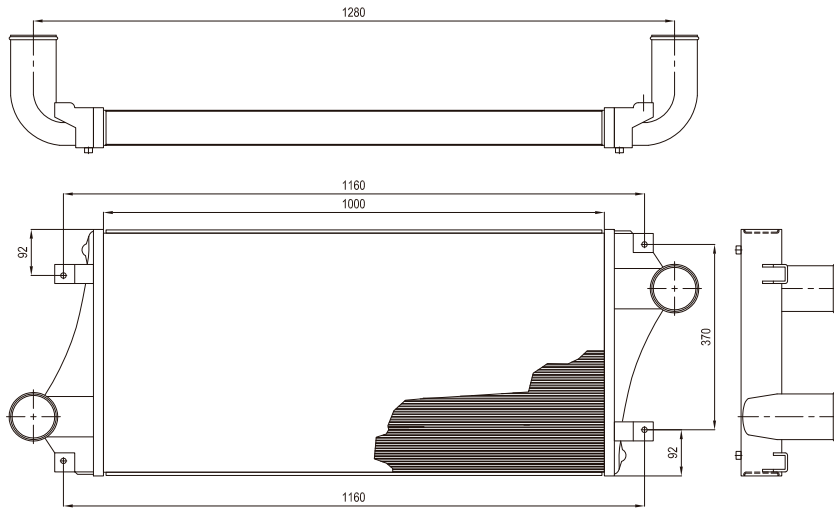

Intercooler IY031

MARCA MODELO	ALTO	ANCHO	ESPESOR
Youngman	1035	900	65

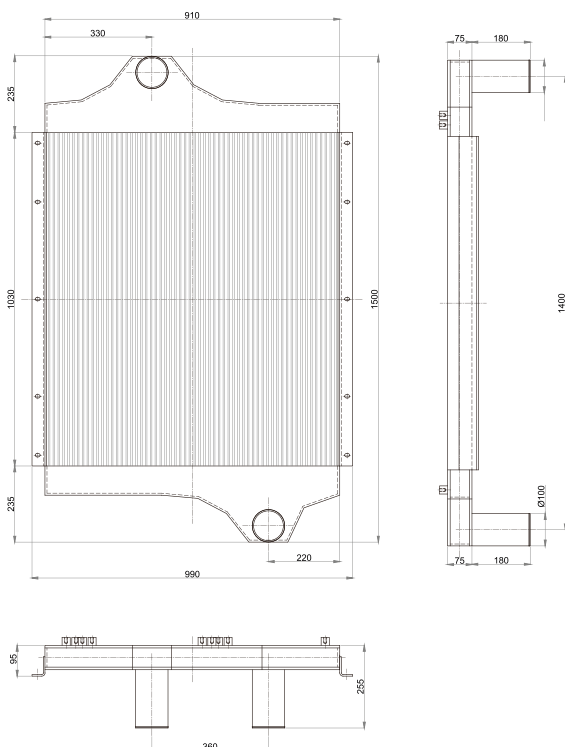





ZONA NORTE

CIA Radomiro Tomic 365
Sector La Negra, Antofagasta.

ZONA CENTRO SUR

Santa Mónica #3550
San Bernardo, Santiago.

www.inpparadiadores.cl

